

Instruction Manual

Bluetooth
Data Logger



Introduction

Congratulations on your purchase of this bluetooth datalogger. This datalogger is designed for monitoring temperature, humidity and pressure subject to quality control requirement.

Temperature, humidity and pressure measurements are saved throughout the entire duration of the logging period.

This datalogger is equipped with Bluetooth communication for programming purpose. A free download Bluetooth iOS and Android APP is required. The measurement report output a PDF file and a csv file generated by APP.

Read through the instruction manual before using this logger and APP. The logger is calibrated before shipment.

Product Description

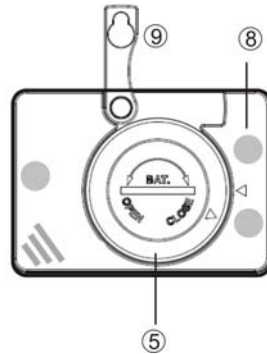
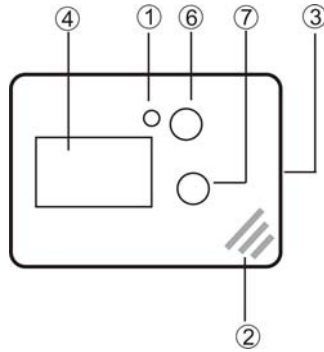

① LED indicator:

Low/High: Red LED blinks every 5 seconds when the measuring set limit value is exceeded during record.

OK: When the logging function is started, the green LED blinks once every 5 seconds when there is no alarm occurs.

② NTC thermistor for temperature measuring and capacitive humidity sensor for humidity measuring.

③ External probe socket in models with external probe port

④ LCD (Liquid Crystal Display).



a. Measured temperature or humidity or pressure. LCD updates and interexchange every 5 seconds.

b. REC flashes every second when logger is in logging mode. While logger is programmed with start delay, REC displays but doesn't flash during the standby status.

c. T1 is air temperature, T2 is external probe temperature

d. H or L displays when measuring set limit value is exceed.

e. MX or MI display when checking MAX or MIN value from logged data.

f. Low battery icon flashes on display every second when battery level is too low to accurately measure and log data.

g. The real time value is broadcasted to APP every 5 seconds.

⑤ Battery cover, operated by 1 pc CR2 battery. Use coin and follow up the direction indicator to open and close the cover. While inserting the

battery, follow up the +/- sign on PCB.

⑥ START/STOP (ON/OFF) key:

After installing the batteries, press key to power on the logger. LCD displays for 2 seconds. Press again to turn off.

After set by App, if the logger is programmed as "Key start", press the Start/Stop button for 5 seconds to start logging. if the logger is programmed as "Key stop", press the Start/Stop button again for 5 seconds to stop logging. In the logging mode, short press key won't power off the logger.

⑦ MAX/MIN key:

Press key to check the MAX or MIN data of all logged data.

⑧ Magnet mounting

3 magnets on the rear side to fix the logger on ventilation shaft or iron rack.

⑨ Hanger

Operation

NOTE:

- 1. Smart phone with Bluetooth is required. iOS above 10 or Android above 5.0 are also a must to run programming APP smoothly.**
- 2. Programming APP can be download for free. Please search for " Nice Logger " in App Store (iOS) or in Play Store (Android) .**

Step1 Configuring the data logger

It is possible to make configuration changes at anytime before the logging function is started.

Once the logger is started, configuration changes cannot be made unless stopping the logging first. If the logger is locked with a Password, the Password is required to make configuration changes.

- Press ON/OFF to power on the logger.
 - Turn ON the Bluetooth of smart device & APP.
- APP will auto scan available and recognized loggers nearby. 3 loggers can be displayed in one page. Click gray dot to switch to other page. Press the desired logger to link for further programming.

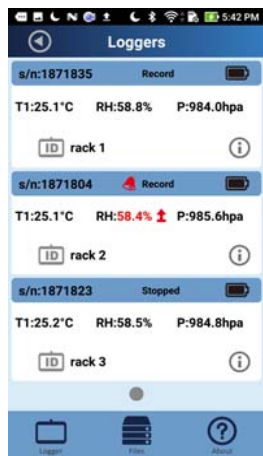

Available Loggers are listed there. 3 loggers per page

- User programmable parameters are grouped as two sections in APP. One is "Configure" and the other one is "Logger ID".

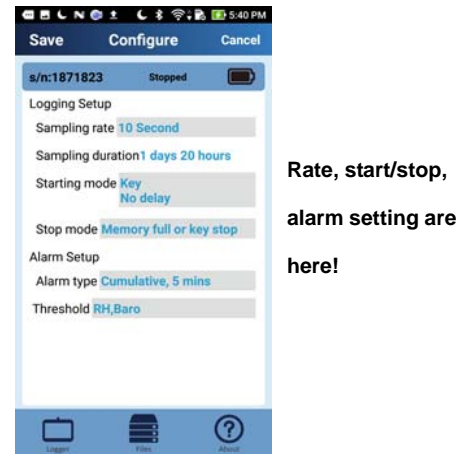
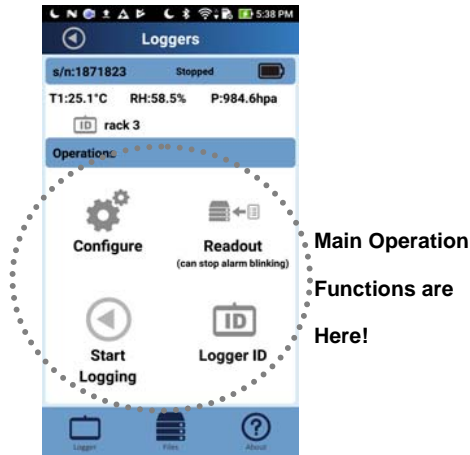

Configure

In Configure, you can program logger with desired way to start/stop logging and things about alarm.

★Sampling rate

Select the sampling interval you need from 10 seconds to 2 hours, the increment of the sampling interval is 10 seconds, so the sampling

interval should be 10 sec. 20sec. 30sec. and so on

★Start & Stop Mode

Select how you would like to Start and Stop the logger. There are 2 choices for start logging and 4 choices for stop logging, no matter which method is picked up, user can always stop logging from APP.

Start choices:

A. By key start: Means pressing key to start logging after set by App

B. By on time start: Means user program a desire time point to start logging after set by App.

Stop choices:

A. Memory loop till key stop: Means pressing key to stop logging. When the memory is full before user pressing stop key, the new data will overwrite the old one till user pressing key to end.

B. Memory full or key stop: Means pressing key to stop logging. When the memory is full, the logging will stop even user didn't press key to stop.

C. Memory loop till Date/Time: Means user program a desire time point to stop logging. When the memory is full but not yet reaching stop time, the new data will overwrite the old one

till time is up.

D. Memory full or on Date/Time: Means user program a desire time point to stop logging. Before reaching the stop time, if the memory is full, the logging stop as well.

★Start delay

Select the start delay from 0 min to 24 hours. For example: If the delay is 10 minutes, and the sampling rate is 20 minutes, the real time to log the first temperature measurement is 10 minutes after the START button is pressed. All measurements after the first measurement will be at a 20 minute (or selected) interval.

The increment of the start delay is 10 minutes, so the start delay should be 10 min. 20 min. 30 min. and so on

★Alarm types

Regardless of the Alarm Type, if the red LED is triggered, it won't stop even the reading return to normal range or logging is stopped. To stop red alarm LED, logging must be stopped and then connect logger to APP to read out data or re-config.

There are two types of alarm types, single and cumulative. However, while users don't choose any parameter in threshold value setting, it will be treated as **NO alarm**.

Single event: an alarm is triggered immediately

when the measured value exceeds the alarm threshold.

Cumulative: an alarm is not triggered when the measured value exceeds the alarm threshold, but only once the overall average value during alarm delay duration exceeds the alarm threshold. While choosing cumulative, alarm delay time is required to input. The adjustable alarm delay interval for a cumulative alarm type can be 5 minutes to 12 hours, the increment of the cumulative interval is 5 minutes, so the start delay should be 5 min. 10 min. 15 min. and so on

★Alarm Threshold

Select the parameter and input threshold values. While users don't choose any parameter in threshold value setting, it will be treated as **NO alarm**.

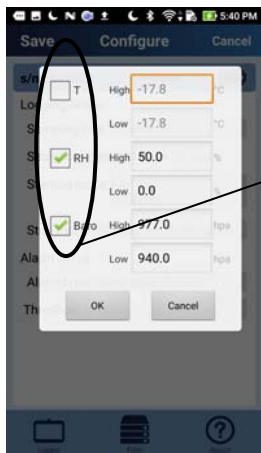

If you didn't tick any parameter here, it will be treated as NO alarm.

For example: Temp. is marked, High is 8 °C and Low is 2 °C, it means that an alarm condition will occur below 2 °C, or above 8 °C. The programmable alarm limit of each parameter is limited to one decimal.

Once all the programming is done, press "Save" to confirm the setting and then you may continue to link another logger to program next one.

Logger ID

In Logger ID, you can program logger with specific identification to distinguish it from other logger.

★Password

The Password function is default OFF. The user may enable it to prevent unauthorized reprogramming on App. A Password may have up to 4 numeric characters (0, 1, 2, ...,9)

★Device Name

A user defined name, or descriptor, can be input under Device Name. It will be displayed on the report as the Title, with a maximum of 7 characters.

★Unit of Measurement (UoM)

Select the unit that will be displayed on the report and LCD. The selections are Metric or Imperial. In Metric, it is Celsius for temperature and hpa for pressure. In Imperial, it is Fahrenheit

for temperature and inHg for pressure.

★Time zone

Before programming the logger the user must assure that the smart phone is set for the correct time zone. The logger will auto synchronize to the time zone of the smart phone, when Save is pressed. Time zone changes over the transit distance are not adjusted in the logged data.

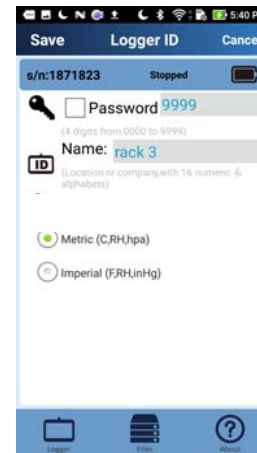

Password, logger name & unit are programmed here!

Once all the programming is done, press "Save" to confirm the setting and then you may continue to link another logger to program next one.

Step2 Start logging

- Depended on what kind of start mode you pick up, you may press "START" key for 5 seconds to start the logging. Logger programmed with starting time will automatically start at desired time. Or, you may start logging any time from APP.

- "REC" will appear and flash on LCD to indicate the logging is activated. Measured parameters update and interexchange on LCD every 5 seconds.

- If Logger is programmed with Start delay, the "REC" will appear (**not flashing**) to show the logging is started and in standby status.

- During the logging, the green LED will blink every 5 seconds if there is no alarm occurred. If any, it turns into flashing red LED.

- If the red LED is triggered, it won't stop even the reading return to normal range or logging is stopped. To stop red alarm LED, logging must be stopped and then connect logger to APP to read out data or re-config.

- Press MAX/MIN key any time to review the maximum and minimum data stored in memory.

Step3 Download data

- This APP and logger provides you an advanced design to review logged data graph before logging task is ended. It means you can readout the logged data anytime without stopping the logging.

- Of course you may still choose to stop the logging task first before downloading data.

Depended on what kind of stop mode you pick up in configure, you may press "STOP" key for 5

seconds to stop the logging. Logger programmed with stop time will automatically stop at desired time. Or, you can stop logging anytime from APP.

- After stopping the logging (or without stopping it), choose “Readout” to download the logged data from logger.

Step4 Report generation

-Go to **Files** function of APP and input the serial number of the logger which you want to generate the report.

-Click the displayed simplified graph to check the detail statistic data. It might take some seconds to updated depends on mobile phones.

- Choose function “Convert to PDF” or “Convert to csv” to generate the report in preferred format.

- The created csv report contains all data shown in PDF report except the graph.

- The created report can be mailed out to share data.

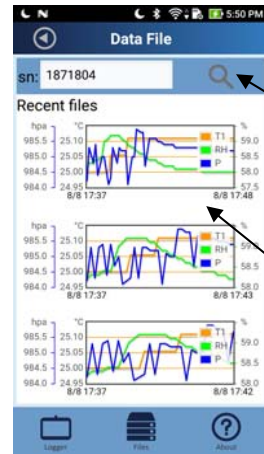

Input s/n here to search read out data

Click graph to see details

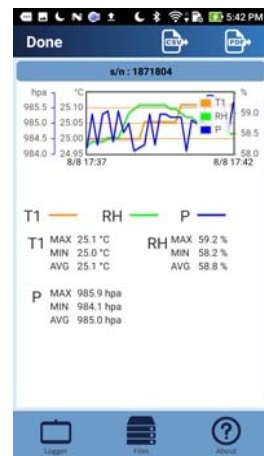

Click to generate report in PDF or csv. Can be saved or send out via email

Technical data

Model
 Model 1 : Temperature logger
 Model 2: Temperature + Ext. temp. logger
 Model 3: Temperature + Humidity logger
 Model 4: Temperature +Humidity +Barometric logger

Temp. & Ext. measurement -30.0~70.0°C (-22.0~158.0°F)
 Temp. resolution 0.1°C (0.1°F)
 Temp. accuracy +/-0.5°C
 Humidity 0.1~99.9%rH
 Humidity res. 0.1%rH
 Humidity accu. +/-3% at 25 °C(10-90%rH), others +/-5%

Barometric 300~1100hpa; 8.9~32.5inHg
 Baro res. 1hpa;0.1inHg
 Baro accu.(hpa) +/-3(0~60 °C), +/-5 (-20~0 °C), the rest is not specified.

Logging Type Multiple use
 Sampling points
 Model 1: 48000 points
 Model 2: 24000 Temp. +24000 ext. Temp.
 Model 3: 24000 Temp. +24000 Humidity
 Model 4: 16000 Temp.+ 16000 Humidity+ 16000 Baro.

Battery Life 3 months
 Operating temp. -30~70°C (Logging status); room temp.(PC status)
 Operating RH% Humidity < 80%
 Storage temp. -40~85°C
 Storage RH% Humidity <90%
 Weight ~90g
 Battery 1PC 3.0V CR2
 Sampling interval 10 second to 2 hours
 Start delay 0 mins to 24 hours
 Alarm range Temp: -30.0~70.0°C
 Humidity:1~99%rH
 Baro:300~1100hpa
 Alarm delay 0, 5, 10, 15... 720 minutes
 Alarm type Single, Cumulative, Disable
 Operation keys 2 Keys, Start/Stop & MX/Mn
 LED indicator REC, High /Low alarm

Protection class
 Model 1: IP67
 Model 2: IP65
 Model 3: IP65, not include sensor
 Model 4: IP65, not include sensor.

Directives EN12830
 Operating System iOS and Android

Error Code

Why?	In model 2 only. External probe is unplugged
Solution	Check the contact between probe and logger
E02	
Why?	Measured value is below specified range
Solution	Put the logger in specified range
E03	
Why?	Measured value is above specified range
Solution	Put the logger in specified range
E04	
Why?	In humidity display of model 3 & 4 only, means temperature is in error mode
Solution	Solve the error issue of temp. sensor
E11	
Why?	In humidity display of model 3 & 4 only, means humidity calibration is fail
Solution	Re-calibrate the humidity
E31	
Why?	Microprocessor is fail
Solution	Contact distributor for after service
E33	
Why?	In humidity display of model 3&4 only, means humidity measuring is fail
Solution	Contact distributor for after service
Why red LED is flashing but recorded data is OK	
Why?	Alarm detection works every 5 seconds but data logging are possibly programmed as every 2 hours. In this condition, if alarm happens between two logging points, it might lead the recorded data is OK but red LED is flashing, especially if the alarm mode is set as “Single”.
Solution	To program the alarm function as cumulative can reduce this situation

FCC Caution: Any changes or modifications not expressly approved by the

party responsible for compliance could void the user's authority to operate

this equipment. This device complies with Part 15 of the FCC Rules.

Operation is subject to the following two conditions: (1) This device may not

cause harmful interference, and (2) this device must accept any interference

received, including interference that may cause undesired operation.