

CT6847A

AC/DC CURRENT PROBE

Maximum rating 2000 A (DC), high-stability, high-accuracy, high-CMRR, high-performance fluxgate technology, clamp type



Features

- $\pm 0.15\%$ rdg. Accuracy
- 20 ppm linearity
- Frequency band DC to 70 kHz
- Guaranteed accuracy temperature range : -40°C to 85°C
- Voltage output
- No warm-up required
- Measurable aperture $\phi 50$ mm
- The Power Analyzer PW8001, PW4001 or the Data Logger LR8101, LR8102 with the Power Measurement Module M7103 automatically recognizes the current sensor's information (phase shift data, sensor model name, rated current, serial number) when connected.

Applications

- Automotive (WLTP, SAE J1634, energy flow, ADAS and EVSE calibration)
- Battery SOC
- Renewable energy (PV, PCS manufacturing and calibration)
- Efficiency of high-efficiency energy converters
- Industrial drones
- Data center consumption current

Specification highlights	Symbol	Unit	Min.	Typ.	Max.
Nominal primary DC current	$I_{PN DC}$	A	-2000		2000
Nominal primary AC current	$I_{PN AC}$	Arms			1400
Measurement range	I_{PM}	A	-2000		2000
Nominal output voltage	V_{out}	V	-2		2
Primary/secondary ratio	Ratio	mV/A		1	
Linearity error	ϵ_L	ppm		± 20	
Bandwidth (± 3 dB)	f	kHz		70	
Withstand voltage (1 mA, 50/60 Hz for 1 minute)	U_d	kV			4.26
Power supply voltage	U_c	V	-12		12
Operating temperature range	T_A	°C	-40		85
Output cable length	L_{cable}	m		3	

CT6847A

AC/DC CURRENT PROBE

Electrical specifications at TA = 23°C ±5°C, supply voltage (by using external PSU) = ±12 V unless otherwise stated

Parameter	Symbol	Unit	Min.	Typ.	Max.	comment
Nominal primary DC current	I _{PN DC}	A	-2000		2000	Refer to "Figure 1. Frequency derating"
Nominal primary AC current	I _{PN AC}	A rms			1400	Refer to "Figure 1. Frequency derating"
Measuring range	I _{PM}	A	-2000		2000	Refer to "Figure 1. Frequency derating"
Maximum input current	I _{MAX}	A peak	-2400		2400	At temperatures below 40°C, peak values are permitted only within a single cycle of a periodic waveform lasting 10 ms or longer (design value, outside the accuracy guarantee range).
Nominal output voltage	V _{out}	V	-2		2	
Primary / secondary ratio	Ratio	mV/A		1		
Bandwidth (-3dB)	f	kHz		70		Refer to "Figure 2. Frequency characteristics"
Output resistance		Ω	40	50	60	
Linearity error	ε _L	ppm		±20		
Offset adjustment range		μV	-700		700	Typical
Output noise	noise	μV rms			200	Measurement bandwidth: DC to 100 kHz
Effects of temperature Amplitude sensitivity Offset voltage		ppm of reading/°C ppm of full scale/°C	-50 -10		50 10	The numerical values are added to the measurement accuracy according to the temperature difference of 0 °C or 40 °C if operating temperatures are outside 0 °C to 40 °C.
Effects of magnetization		mA			150	Converted to input current, after input of 2000 A DC
Common mode voltage rejection ratio DC to 1 kHz 1 kHz to 10 kHz 10 kHz to 50 kHz	CMRR	dB	130 120 100			Effect on output voltage/common-mode voltage
Effects of conductor position DC to 100 Hz		% of reading			0.15	For 100 A input with a conductor outer diameter of 10mm
Effects of external magnetic field		mA			150	converted to input current, DC or 60 Hz magnetic field of 400 A/m
Effects of radiated radio-frequency electromagnetic field		% of full scale		3		10 V/m
Effects of conducted radio-frequency electromagnetic field		% of full scale		3		10 V
Fluxgate excitation frequency	f _{Exc}	MHz		1.65		
Power supply voltages	U _c	V	-12		12	
Current consumption (DC)	I _{sdc}	mA	-550		550	DC 2000 A with ±12 V
Current consumption (AC)	I _{sac}	mA	-400		400	1400 A (DC, 55 Hz) with ±12 V

Isolation specifications

Parameter	Unit	Value	Comment
Withstand voltage (AC/DC), between jaws and output terminal (when attached to line under measurement)	kV	4.26	AC/DC (sensitivity current: 1 mA), 50 Hz/60 Hz, 1 minute Between jaws and output terminal (when attached to line under measurement)
Standards			Safety: EN 61010 EMC: EN 61326

HIOKI E.E. CORPORATION

All information correct as of May 11, 2026. HIOKI E.E. CORPORATION

Company names and product names appearing in this catalog are trademarks or registered trademarks of various companies.

Written in Japan

All specifications are subject to change without notice.

CT6847A

AC/DC CURRENT PROBE

Environmental and mechanical characteristics

Parameter	Symbol	Unit	Min.	Typ.	Max.	Comment
Operating environment (altitude)		m			2000	Indoor use, pollution degree 2
Ambient operating temperature range	T _A	°C	-40		85	
Ambient storage temperature range	T _{Ast}	°C	-40		85	
Relative humidity	RH	%			80	Non-condensing
Measurable conductor diameter	D _{meas}	mm			50	
Dimensions	W H D	mm		238 116 35		
Output cable length	L _{cable}	m		3		
Weight	m	g		1040		

Measurement accuracy (total accuracy including uncertainty in calibration system etc.)

Electrical specifications at T_A = 0°C to 40°C, supply voltage (by using external PSU) = ±12 V unless otherwise stated

Frequency [Hz]	Amplitude		Phase [±°]
	[±% of reading]	[±% of full scale]	
DC	0.15	0.01	—
DC < f ≤ 16	0.2	0.01	0.1°
16 < f ≤ 100	0.15	0.01	0.1°
100 < f ≤ 500	0.5	0.02	(0.1 + 0.5 × f)°
500 < f ≤ 1 k	1.0	0.02	
1 k < f ≤ 5 k	2.0	0.02	
5 k < f ≤ 20 k	0.45 × f	0.02	
20 k < f ≤ 50 k	0.45 × f	0.05	
Frequency band	70 kHz (-3 dB, typical)		—

• Unit for f in the calculation formulas: kilohertz (kHz)

• The amplitude and phase accuracy are defined for an input current not more than the rated current and within the frequency derating range. However, the design value is defined for the frequency range of DC < f < 10 Hz. Full scale is specified as 2000 A (or 2 V).

Definition of on accuracy (total accuracy including uncertainty in calibration system etc.)

Reading (displayed value) error: Indicates the value displayed by the instrument. Limit values for reading errors are expressed as a percentage of the reading (“% of reading” or “% rdg.”).

Range error: Indicates the instrument’s range. Limit values for range errors are expressed as a percentage of the range (“% of range”).

Full scale (rated current) error: Indicates the rated current. Limit values for full-scale errors are expressed as a percentage of full scale (“% of full scale” or “% f.s.”).

Calibration: The accuracy of HIOKI products includes all factors that affect the measurement results, such as calibration system errors, ambient temperature, and secular change, as “uncertainty”.

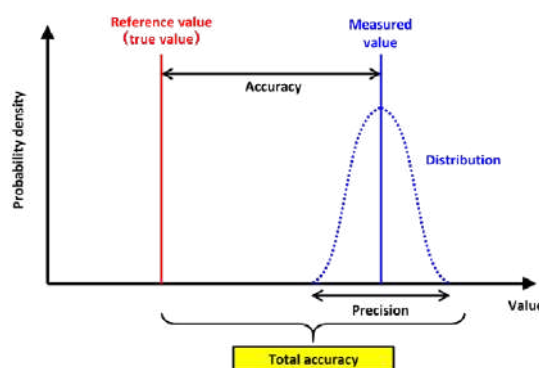

HIOKI is accredited as an official ISO/IEC 17025 calibrator.

HIOKI E.E. CORPORATION

All information correct as of May 11, 2026. HIOKI E.E. CORPORATION

Company names and product names appearing in this catalog are trademarks or registered trademarks of various companies.

Written in Japan





All specifications are subject to change without notice.

CT6847A

AC/DC CURRENT PROBE

Specific accuracy calculation example

How to measure the current **DC 1000 A** of a conductor with a diameter of ϕ 50 mm or less with high accuracy.
 Guaranteed specifications at TA = 0°C to 40°C

Measuring instrument configuration	CT6847A	CT9555	L9217 + 9704	DM7276
External view				
Range (connection)	2000 A (2000 mV)	Front OUTPUT terminal (BNC terminal)	✓	1000 mV
Output voltage	1000 A × 2000 mV / 2000 A = 1000 mV			
Error (reading)	0.15%	—	—	0.0011%
Error (full scale)	0.01%	—	—	3 μV
Total error	1000 mV × (0.15 + 0.0011) % + 2000 mV × 0.01% + (3 μV × 10 ⁻³) mV = 1.714 mV			
Total error (input equivalent)	1.714 mV / 2000 mV × 2000A = 1.714 A			
Error range	1000 A ± 1.714 A → 998.286 A to 1001.714 A			

Definition of linearity error

Indicates that the output voltage changes linearly in response to the input current. A regression line is attained by measuring the output voltage in the sequence below in 400 A intervals:
 +2000 A → 0 A → -2000 A → 0 A → +2000 A
 It is defined as the difference between the regression line calculated from the above measurements and the measurement points.

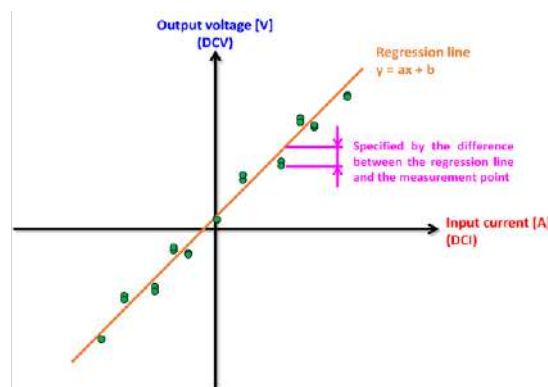

Definition of offset error

Offset error ϵ_o : Specified by the ratio of the average value (μ) of the measured values of the offset voltage and the rated current (I_{max}) of each current sensor.

$$\epsilon_o = \mu / I_{max} \text{ [ppm]}$$

Definition of amplitude error

Amplitude error ϵ_G : An index showing the degree of flatness of the frequency characteristics of gain.
 DC error is defined as "linearity error + offset error."
 AC error is defined as deviation from the 55 Hz measurement point.

$$\epsilon_{GDC} = \epsilon_L + \epsilon_o \text{ [ppm]}$$

$$\epsilon_{GAC} = \frac{\text{Gain}(f) - \text{Gain}(55 \text{ Hz})}{\text{Gain}(55 \text{ Hz})} \times 100 \text{ [%]}$$

CT6847A

AC/DC CURRENT PROBE

Figure 1. Frequency derating

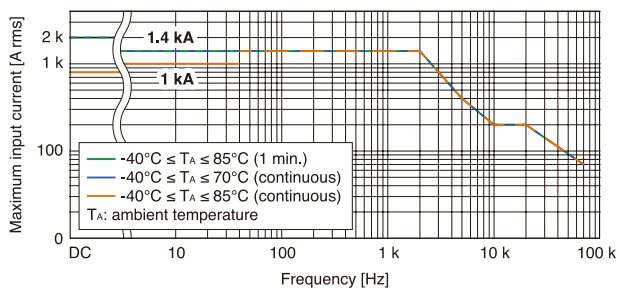

Defined when neither adjacent current nor external magnetic field exists, and the conductor is located at the center of the jaw aperture.

Figure 2. Frequency characteristics

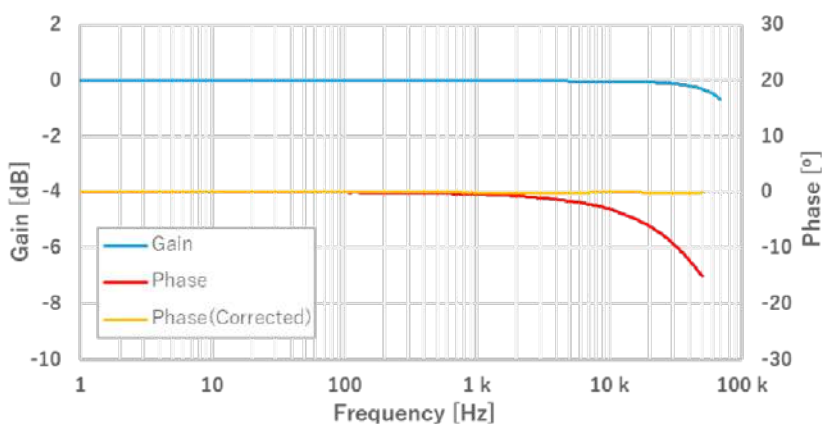

Phase Compensation Values

Enter the following values (representative values) when performing phase compensation on the PW6001 or PW3390.

When connecting to PW8001, PW4001 or LR8101/LR8102 with M7103, it will be set automatically.

CT6847A: 10 kHz, -3.02°

Figure 3. Part names

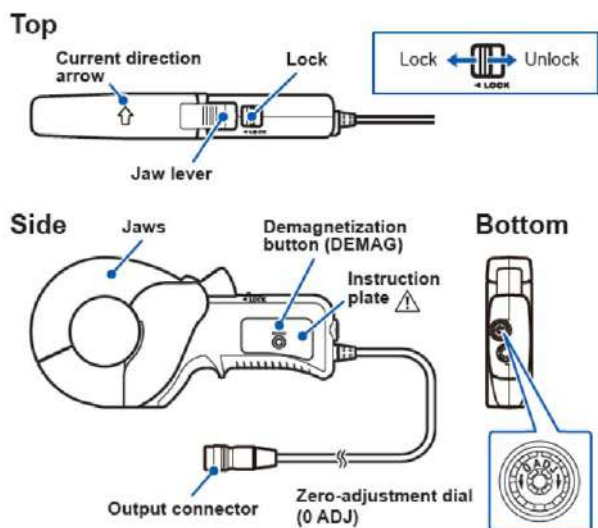

CT6847A

AC/DC CURRENT PROBE

Figure 4. Demagnetization (DEMAG) and zero adjustment (0 ADJ)

Immediately after the device is turned on or if an overcurrent exceeding the rated current is input, the device will output an offset. The offset will cause an error in DC current measurement, so perform demagnetization and zero adjustment as follows:

When connected to the CT9555, CT9556, or CT9557

1. Open the jaws and then press the demagnetization (DEMAG) buttons on the device and the CT9555, CT9556, or CT9557.
2. Open and close the jaws multiple times, and check that the display (offset output) on the measuring instrument is stable.
3. Lock the jaws.
4. Turn the zero adjustment dial (0 ADJ). Check the offset output displayed on the measuring instrument and make adjustments until the value is within:

- ±0.5 mV (CT6841A)
- ±0.2 mV (CT6843A, CT6844A, CT6845A, CT6846A)
- ±0.1 mV (CT6847 A)

When connected to equipment with a zero adjustment function

1. Lock the jaws.
2. Align the depression on the zero adjustment dial (0 ADJ) with the fitting surface.
3. Execute the zero adjustment from the measuring instrument.

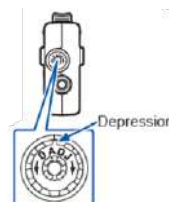

- Zero adjustment cannot be performed while a current is being input.
- The offset output varies depending on the surrounding environment, such as the temperature, terrestrial magnetism, and equipment that generates magnetic fields. Perform zero adjustment with the device at the location where you will measure current.
- Mechanical shocks such as dropping the device may cause the offset to shift.
- If zero adjustment is unsuccessful, perform demagnetization (DEMAG) several times with the jaws closed.

Measurement procedure

1. Connect the device to a measuring instrument that is powered off.
2. Turn on the measuring instrument.
3. Perform demagnetization (DEMAG) and zero adjustment (0 ADJ). See: "Demagnetization (DEMAG) and zero adjustment (0 ADJ)" (p. 17)
4. Unlock and open the jaws.
CT6845A, CT6846A, CT6847A
 (1) Unlock
 (2) Open the jaws (press the open/close lever)

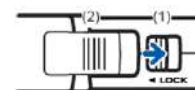
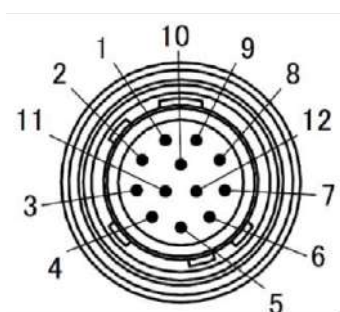
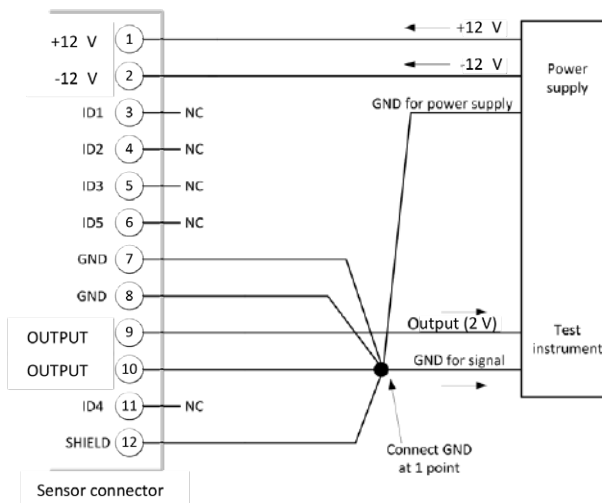

Figure 5. Pin assignment (when not using the sensor units CT9555, CT9556, or CT9557)



Output connector HIOKI ME15W of current sensors
 HIROSE ELECTRIC CO., LTD.
 HR10A-10P-12P (74)



CT6847A

AC/DC CURRENT PROBE

Figure 6. Options and main combination

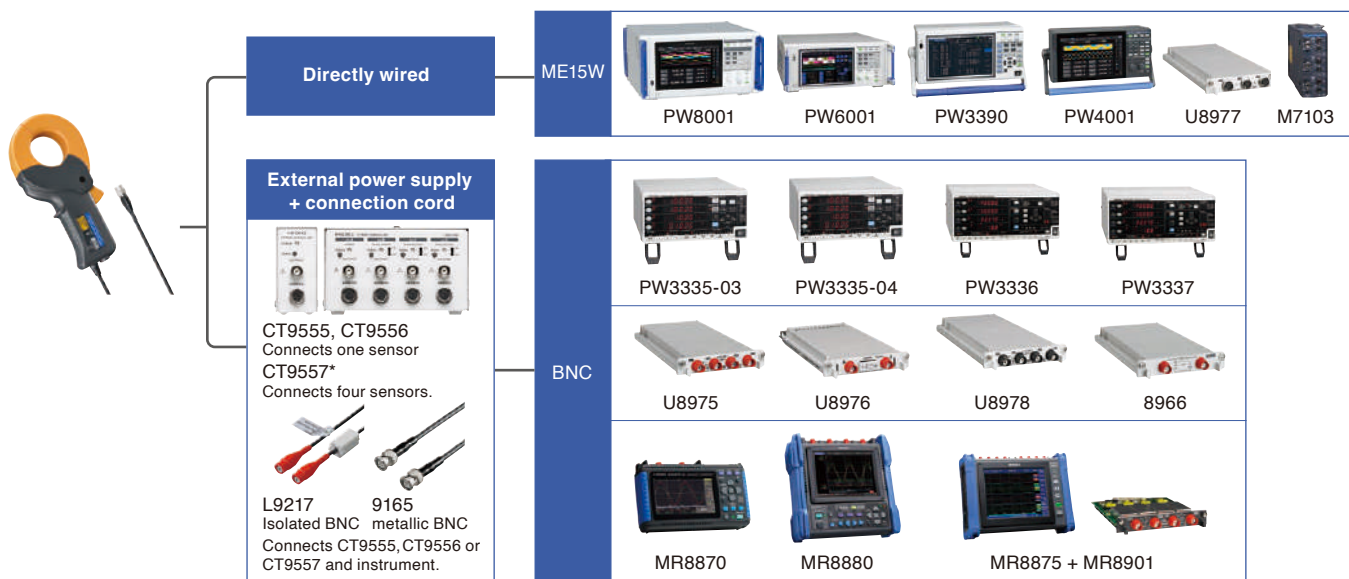

The CT9557 not only functions as a 4-channel power supply, but can also output additive waveform and RMS output from up to four input waveforms.

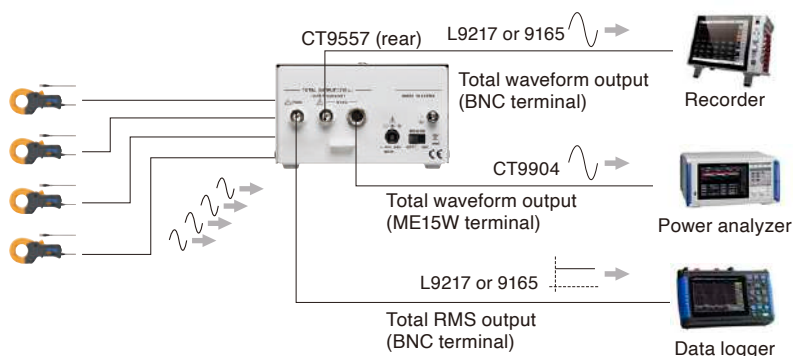

CT9904 CONNECTION CABLE
ME15W (12 pin) terminal - ME15W (12 pin) terminal
The CT9904 is the cable for the CT9557 addition output and POWER ANALYZER PW8001/PW6001/PW4001/PW3390/M7103 connection.



CT9902 EXTENSION CABLE
ME15W (12 pin) terminal - ME15W (12 pin) terminal
The CT9902 can be used to extend a current sensor's cable by 5m. Up two of these cables can be used for a maximum extension of 10 m.
*When using the CT9902, an additional accuracy needs to be added. For details, see the sensor's user manual.

Links

1. Web site
https://www.hioki.com/global/products/current-probes/high-clamp/id_1387459

2. Accuracy calculation tools
PW8001, PW6001, PW4001, PW3390, LR8101/LR8102 (M7103): <https://hioki-cierto.com/gl/fm50bha8wk/>

Files and information such as the Power Analyzer or the Data Logger with the Power Measurement Module accuracy calculation tools are updated regularly. Instead of downloading them once and using them for a long time, download them from the download link just before using them.

HIOKI E.E. CORPORATION | All information correct as of May 11, 2026. HIOKI E.E. CORPORATION
Company names and product names appearing in this catalog are trademarks or registered trademarks of various companies.
Written in Japan
All specifications are subject to change without notice.